



Operating Guide

PS 5000 A

DC Laboratory Power Supply



TABLE OF CONTENTS

1 GENERAL

1.1	About this document	4
1.1.1	Retention and use	4
1.1.2	Copyright	4
1.1.3	Validity	4
1.1.4	Symbols and warnings	4
1.2	Warranty	4
1.3	Limitation of liability	4
1.4	Disposal of equipment	5
1.5	Product key	5
1.6	Intended usage	5
1.7	Safety	6
1.7.1	Safety notices	6
1.7.2	Responsibility of the user	6
1.7.3	Responsibility of the operator	7
1.7.4	User requirements	7
1.7.5	Alarm signals	8
1.8	Technical Data	8
1.8.1	Approved operating conditions	8
1.8.2	General technical data	8
1.8.3	Specific technical data	9
1.8.4	Views	15
1.9	Construction and function	18
1.9.1	General description	18
1.9.2	Scope of delivery	18
1.9.3	Accessories	18
1.9.4	The control panel (HMI)	19
1.9.5	USB port (rear side)	20
1.9.6	Sense connector (remote sensing)	20

2 INSTALLATION & COMMISSIONING

2.1	Storage	21
2.1.1	Packaging	21
2.1.2	Storage	21
2.2	Unpacking and visual check	21
2.3	Installation	21
2.3.1	Preparation	21
2.3.2	Installing the device	21
2.3.3	Connection to AC supply	22
2.3.4	Connection to DC loads	22
2.3.5	Grounding of the DC output	23
2.3.6	Connection of remote sensing	23
2.3.7	Connecting the USB port (rear side)	24
2.3.8	Initial commission	25
2.3.9	Commission after a firmware update or a long period of non-use	25

3 OPERATION AND APPLICATION

3.1	Personal safety	26
3.2	Operating modes	26
3.2.1	Voltage regulation / Constant voltage	26
3.2.2	Current regulation / constant current / current limiting	26
3.2.3	Power regulation / constant power / power limiting	26
3.3	Alarm conditions	27
3.3.1	Power Fail (only with 640 W models)	27
3.3.2	Overtemperature	27
3.3.3	Overvoltage protection	27
3.3.4	Overcurrent protection	27
3.3.5	Overpower protection	27
3.3.6	Remote sensing	27
3.4	Manual operation	28
3.4.1	Switching the device on	28
3.4.2	Switching the device off	28
3.4.3	Manual adjustment of set values	28
3.4.4	Manually configure protections	29
3.4.5	Switching the DC output on or off	29
3.4.6	Recall feature	30
3.4.7	Control panel (HMI) lock	30
3.5	Remote control	31
3.5.1	General	31
3.5.2	Control locations	31
3.5.3	Remote control via the digital interface	31
3.6	Alarms and supervision	32
3.6.1	Definition of terms	32
3.6.2	Device alarm handling	32
3.7	Other applications	33
3.7.1	Parallel operation	33
3.7.2	Series connection	33
3.7.3	Operation as battery charger	33

4 SERVICE AND MAINTENANCE

4.1	Maintenance / cleaning	34
4.2	Fault finding / diagnosis / repair	34
4.2.1	Replacing a defect mains fuse	34
4.3	Firmware updates	34

5 CONTACT AND SUPPORT

5.1	Repairs	34
5.2	Contact options	34

1. General

1.1 About this document

1.1.1 Retention and use

This document is to be kept in the vicinity of the equipment for future reference and explanation of the operation of the device. This document is to be delivered and kept with the equipment in case of change of location and/or user.

1.1.2 Copyright

Reprinting, copying, also partially, usage for other purposes as foreseen of this manual are forbidden and breach may lead to legal process.



1.1.3 Validity

This manual is valid for the following equipment:

Model	Article no.	Model	Article no.	Model	Article no.
PS 5040-10 A	05100300	PS 5040-20 A	05100303	PS 5040-40 A	05100306
PS 5080-05 A	05100301	PS 5080-10 A	05100304	PS 5080-20 A	05100307
PS 5200-02A	05100302	PS 5200-04 A	05100305	PS 5200-10 A	05100308

1.1.4 Symbols and warnings

Warning and safety notices as well as general notices in this document are shown in a box with a symbol as follows:

	Symbol for a life threatening danger
	Symbol for general safety notices (instructions and damage protection bans) or important information for operation
	<i>Symbol for general notices</i>

1.2 Warranty

The manufacturer guarantees the functional competence of the applied technology and the stated performance parameters. The warranty period begins with the delivery of free from defects equipment.

Terms of guarantee are included in the general terms and conditions (TOS) of EA Elektro-Automatik GmbH.

1.3 Limitation of liability

All statements and instructions in this manual are based on current norms and regulations, up-to-date technology and our long term knowledge and experience. The manufacturer accepts no liability for losses due to:

- Usage for purposes other than designed
- Use by untrained personnel
- Rebuilding by the customer
- Technical changes
- Use of not authorized spare parts

The actual delivered device(s) may differ from the explanations and diagrams given here due to latest technical changes or due to customized models with the inclusion of additionally ordered options.

1.4 Disposal of equipment

A piece of equipment which is intended for disposal must, according to European laws and regulations (ElektroG, WEEE) be returned to the manufacturer for scrapping, unless the person operating the piece of equipment or another, delegated person is conducting the disposal. Our equipment falls under these regulations and is accordingly marked with the following symbol:



1.5 Product key

Decoding of the product description on the label, using an example:

PS 5 080 - 10 A

PS	5	080	-	10	A	Generation: A = 1st generation
						Maximum current of the device in Ampere
						Maximum voltage of the device in Volt
						Series : 5 = Series 5000
						Type identification: PS = Power Supply, usually programmable PSI = Power Supply Intelligent, always programmable ELR = Electronic Load with Recovery

1.6 Intended usage

The equipment is intended to be used, if a power supply or battery charger, only as a variable voltage and current source, or, if an electronic load, only as a variable current sink.

Typical application for a power supply is DC supply to any relevant user, for a battery charger the charging of various battery types and for electronic loads the replacement of an ohmic resistor by an adjustable DC current sink in order to load relevant voltage and current sources of any type.



- Claims of any sort due to damage caused by non-intended usage will not be accepted.
- All damage caused by non-intended usage is solely the responsibility of the operator.

1.7 Safety

1.7.1 Safety notices

Mortal danger - Hazardous voltage



- Electrical equipment operation means that some parts can be under dangerous voltage. Therefore all parts under voltage must be covered! This basically applies to all models, though 40 V models according to SELV can not generate hazardous DC voltage.
- All work on connections must be carried out under zero voltage (output not connected to load) and may only be performed by qualified and informed persons. Improper actions can cause fatal injury as well as serious material damage.
- Never touch cables or connectors directly after unplugging from mains supply as the danger of electric shock remains.
- Never touch the contacts on DC output terminal directly after switching off the DC output, because there can still be dangerous voltage present, sinking more or less slowly depending on the load! There also can be dangerous potential between negative DC output to PE or positive DC output to PE due to charged X capacitors.



- The equipment must only be used as intended
- The equipment is only approved for use within the connection limits stated on the product label.
- Do not insert any object, particularly metallic, through the ventilator slots
- Avoid any use of liquids near the equipment. Protect the device from wet, damp and condensation.
- For power supplies and battery chargers: do not connect users, particularly low resistance, to devices under power; sparking may occur which can cause burns as well as damage to the equipment and to the user.
- For electronic loads: do not connect power sources to equipment under power, sparking may occur which can cause burns as well as damage to the equipment and to the source.
- ESD regulations must be applied when plugging interface cards or modules into the relative slot
- Interface cards or modules may only be attached or removed after the device is switched off. It is not necessary to open the device.
- Do not connect external power sources with reversed polarity to DC input or outputs! The equipment will be damaged.
- For power supply devices: avoid where possible connecting external power sources to the DC output, and never those that can generate a higher voltage than the nominal voltage of the device.
- For electronic loads: do not connect a power source to the DC input which can generate a voltage more than 120% of the nominal input voltage of the load. The equipment is not protected against over voltage and may be irreparably damaged.
- Always configure the various protecting features against overcurrent, overvoltage etc. for sensitive loads to what the target application requires!

1.7.2 Responsibility of the user

The equipment is intended for industrial operation. Therefore the operators are governed by the legal safety regulations. Alongside the warning and safety notices in this manual the relevant safety, accident prevention and environmental regulations must also be applied. In particular the users of the equipment:

- must be informed of the relevant job safety requirements
- must work to the defined responsibilities for operation, maintenance and cleaning of the equipment
- before starting work must have read and understood the operating manual
- must use the designated and recommended safety equipment.

1.7.3 Responsibility of the operator

Operator is any natural or legal person who uses the equipment or delegates the usage to a third party, and is responsible during its usage for the safety of the user, other personnel or third parties.

The equipment is intended for industrial operation. Therefore the operators are governed by the legal safety regulations. Alongside the warning and safety notices in this manual the relevant safety, accident prevention and environmental regulations must also be applied. In particular the operator has to

- be acquainted with the relevant job safety requirements
 - identify other possible dangers arising from the specific usage conditions at the work station via a risk assessment
 - introduce the necessary steps in the operating procedures for the local conditions
 - regularly control that the operating procedures are current
 - update the operating procedures where necessary to reflect changes in regulation, standards or operating conditions.
 - define clearly and unambiguously the responsibilities for operation, maintenance and cleaning of the equipment.
 - ensure that all employees who use the equipment have read and understood the manual. Furthermore the users are to be regularly schooled in working with the equipment and the possible dangers.
 - provide all personnel who work with the equipment with the designated and recommended safety equipment
- Furthermore, the operator is responsible for ensuring that the device is at all times technically fit for use.

1.7.4 User requirements

Any activity with equipment of this type may only be performed by persons who are able to work correctly and reliably and satisfy the requirements of the job.

- Persons whose reaction capability is negatively influenced by e.g. drugs, alcohol or medication may not operate the equipment.
- Age or job related regulations valid at the operating site must always be applied.



Danger of injury!

Improper operation of the device can cause person or object damage. Only persons who have the necessary training, knowledge and experience may use the equipment.

Delegated persons are those who have been properly and demonstrably instructed in their tasks and the attendant dangers.

Qualified persons are those who are able through training, knowledge and experience as well as knowledge of the specific details to carry out all the required tasks, identify dangers and avoid personal and other risks.

1.7.5 Alarm signals

The equipment the possibility to signal alarm conditions, however, not danger situations. The signals are optical, on the display as text). All alarms will cause the device to permanently or temporarily switch off the DC output.

The meaning of the signals is as follows:

Signal OT (OverTemperature)	<ul style="list-style-type: none"> • Overheating of the device • DC output will be switched off temporarily • Non-critical
Signal OVP (OverVoltage)	<ul style="list-style-type: none"> • Overvoltage shutdown of the DC output due to high voltage entering the device or generated by the device itself due to a defect • Critical! The device and/or the load could be damaged
Signal OCP (OverCurrent)	<ul style="list-style-type: none"> • Shutdown of the DC output due to excess of the preset limit • Non-critical, protects the load from excessive current consumption
Signal OPP (OverPower)	<ul style="list-style-type: none"> • Shutdown of the DC output due to excess of the preset limit • Non-critical, protects the load from excessive power consumption
Signal PF (Power Fail)	<ul style="list-style-type: none"> • DC output shutdown due to AC undervoltage or defect of the AC input circuit • Critical on overvoltage! AC input circuit could be damaged

1.8 Technical Data

1.8.1 Approved operating conditions

- Use only inside dry buildings
- Ambient temperature 0-50°C
- Operational altitude: max. 2000 m above sea level
- Max 80% RH up to 30°C, linear decrease to 50% RH at 50°C

1.8.2 General technical data

Display: 7 segment type, 9 digits (upper row), 2x 4 digits (middle row), status symbols

Controls: 2 rotary knobs with button function, 5 pushbuttons

The nominal values for the device determine the maximum adjustable ranges.

1.8.3 Specific technical data

160 W	Model		
	PS 5040-10 A	PS 5080-05 A	PS 5200-02 A
AC Input			
Input voltage	90...264 V AC	90...264 V AC	90...264 V AC
Input connection	1ph,N,PE	1ph,N,PE	1ph,N,PE
Input frequency	50/60 Hz	50/60 Hz	50/60 Hz
Input fuse (internal)	MT 4 A	MT 4 A	MT 4 A
Leak current	< 3.5 mA	< 3.5 mA	< 3.5 mA
Power factor	~ 0.99	~ 0.99	~ 0.99
DC Output			
Max. output voltage U_{Max}	40 V	80 V	200 V
Max. output current I_{Max}	10 A	5 A	2 A
Max. output power P_{Max}	160 W	160 W	160 W
Overvoltage protection range	0...44 V	0...88 V	0...220 V
Overcurrent protection range	0...11 A	0...5.5 A	0...2.2 A
Overpower protection range	0...176 W	0...176 W	0...176 W
Temperature coefficient for set values Δ/K	Voltage / current: 100 ppm		
Voltage regulation			
Adjustment range	0...40.8 V	0...81.6 V	0...204 V
Accuracy ⁽¹⁾ (at 23 ± 5°C)	< 0.1% U_{Nom}	< 0.1% U_{Nom}	< 0.1% U_{Nom}
Line regulation at ±10% ΔU_{AC}	< 0.02% U_{Nom}	< 0.02% U_{Nom}	< 0.02% U_{Nom}
Load regulation at 0...100% load	< 0.05% U_{Nom}	< 0.05% U_{Nom}	< 0.05% U_{Nom}
Rise time 10...90% ΔU	Max. 30 ms	Max. 30 ms	Max. 30 ms
Display: Resolution	See section „1.9.4.3. Resolution of the displayed values“		
Display: Accuracy ⁽⁴⁾	≤ 0.2% U_{Nom}	≤ 0.2% U_{Nom}	≤ 0.2% U_{Nom}
Ripple ⁽²⁾	< 40 mV _{PP} < 5 mV _{RMS}	< 80 mV _{PP} < 10 mV _{RMS}	< 150 mV _{PP} < 30 mV _{RMS}
Remote sensing compensation	Max. 6% U_{Nom}	Max. 6% U_{Nom}	Max. 6% U_{Nom}
Current regulation			
Adjustment range	0...10.2 A	0...5.1 A	0...2.04 A
Accuracy ⁽¹⁾ (at 23 ± 5°C)	< 0.2% I_{Nom}	< 0.2% I_{Nom}	< 0.2% I_{Nom}
Line regulation at ±10% ΔU_{AC}	< 0.05% I_{Nom}	< 0.05% I_{Nom}	< 0.05% I_{Nom}
Load regulation at 0...100% ΔU_{OUT}	< 0.15% I_{Nom}	< 0.15% I_{Nom}	< 0.15% I_{Nom}
Ripple ⁽²⁾	< 15 mA _{RMS}	< 7.5 mA _{RMS}	< 3 mA _{RMS}
Display: Resolution	See section „1.9.4.3. Resolution of the displayed values“		
Display: Accuracy ⁽⁴⁾	≤ 0.2% I_{Nom}	≤ 0.2% I_{Nom}	≤ 0.2% I_{Nom}
Compensation 10%->90% load	< 1.5 ms	< 1.5 ms	< 1.5 ms
Power regulation			
Adjustment range	0...163.2 W	0...163.2 W	0...163.2 W
Accuracy ⁽¹⁾ (at 23 ± 5°C)	< 1% P_{Nom}	< 1% P_{Nom}	< 1% P_{Nom}
Line regulation at ±10% ΔU_{AC}	< 0.05% P_{Nom}	< 0.05% P_{Nom}	< 0.05% P_{Nom}
Load regulation at 10-90% ΔU_{OUT} * ΔI_{OUT}	< 0.75% P_{Nom}	< 0.75% P_{Nom}	< 0.75% P_{Nom}
Display: Resolution	See section „1.9.4.3. Resolution of the displayed values“		
Efficiency ⁽³⁾	~ 92%	~ 92%	~ 93%

(1) Related to the nominal values, the accuracy defines the maximum deviation between an adjusted values and the true (actual) value.

Example: a 80 V model has min. 0.1% voltage accuracy, that is 80 mV. When adjusting the voltage to 5 V, the actual value is allowed to differ max. 80 mV, which means it might be between 4.92 V and 5.08 V.

(2) RMS value: LF 0...300 kHz, PP value: HF 0...20MHz

(3) Typical value at 100% output voltage and 100% power

(4) The display accuracy adds to the general accuracy, so the error (i.e. deviation) will be higher.

160 W	Model		
	PS 5040-10 A	PS 5080-05 A	PS 5200-02 A
Insulation			
Output (DC) to enclosure (PE)	DC minus: permanent max. ± 200 V DC plus: permanent max. ± 200 V + output voltage		
Input (AC) to output (DC)	Max. 2500 V, short-term		
Miscellaneous			
Cooling	Convection (typical direction: front inlet, rear exhaust)		
Ambient temperature	0..50°C		
Storage temperature	-20...70°C		
Humidity	< 80%, not condensing		
Standards	EN 61010, EN 61326		
Overvoltage category	2		
Protection class	1		
Pollution degree	2		
Operational altitude	< 2000 m		
Digital interfaces			
Featured	1x USB-B		
Galvanic isolation from device	Max. 1500 V DC		
USB specification	USB 2.0, socket type B, VCOM driver		
USB response time	max. 2 ms		
Terminals			
Rear side	Auxiliary DC output, AC input, remote sensing, USB-B		
Front side	Main DC output, ground (PE)		
Dimensions			
Enclosure (WxHxD)	200 x 87 x 303 mm		
Total (WxHxD)	200 x 94 x min. 337 mm		
Weight	~ 3 kg	~ 3 kg	~ 3 kg
Article number	05100300	05100301	05100302

320 W	Model		
	PS 5040-20 A	PS 5080-10 A	PS 5200-04 A
AC Input			
Input voltage	90...264 V AC	90...264 V AC	90...264 V AC
Input connection	1ph,N,PE	1ph,N,PE	1ph,N,PE
Input frequency	50/60 Hz	50/60 Hz	50/60 Hz
Input fuse (internal)	MT 4 A	MT 4 A	MT 4 A
Leak current	< 3.5 mA	< 3.5 mA	< 3.5 mA
Power factor	~ 0.99	~ 0.99	~ 0.99
DC Output			
Max. output voltage U_{Max}	40 V	80 V	200 V
Max. output current I_{Max}	20 A	10 A	4 A
Max. output power P_{Max}	320 W	320 W	320 W
Overvoltage protection range	0...44 V	0...88 V	0...220 V
Overcurrent protection range	0...22 A	0...11 A	0...4.4 A
Overpower protection range	0...352 W	0...352 W	0...352 W
Temperature coefficient for set values Δ/K	Voltage / current: 100 ppm		
Voltage regulation			
Adjustment range	0...40.8 V	0...81.6 V	0...204 V
Accuracy ⁽¹⁾ (at 23 ± 5°C)	< 0.1% U_{Nom}	< 0.1% U_{Nom}	< 0.1% U_{Nom}
Line regulation at ±10% ΔU_{AC}	< 0.02% U_{Nom}	< 0.02% U_{Nom}	< 0.02% U_{Nom}
Load regulation at 0...100% load	< 0.05% U_{Nom}	< 0.05% U_{Nom}	< 0.05% U_{Nom}
Rise time 10...90% ΔU	Max. 30 ms	Max. 30 ms	Max. 30 ms
Display: Resolution	See section „1.9.4.3. Resolution of the displayed values“		
Display: Accuracy ⁽⁴⁾	≤ 0.2% U_{Nom}	≤ 0.2% U_{Nom}	≤ 0.2% U_{Nom}
Ripple ⁽²⁾	< 40 mV _{PP} < 5 mV _{RMS}	< 80 mV _{PP} < 10 mV _{RMS}	< 150 mV _{PP} < 30 mV _{RMS}
Remote sensing compensation	Max. 6% U_{Nom}	Max. 6% U_{Nom}	Max. 6% U_{Nom}
Current regulation			
Adjustment range	0...20.4 A	0...10.2 A	0...4.08 A
Accuracy ⁽¹⁾ (at 23 ± 5°C)	< 0.2% I_{Nom}	< 0.2% I_{Nom}	< 0.2% I_{Nom}
Line regulation at ±10% ΔU_{AC}	< 0.05% I_{Nom}	< 0.05% I_{Nom}	< 0.05% I_{Nom}
Load regulation at 0...100% ΔU_{OUT}	< 0.15% I_{Nom}	< 0.15% I_{Nom}	< 0.15% I_{Nom}
Ripple ⁽²⁾	< 20 mA _{RMS}	< 15 mA _{RMS}	< 6 mA _{RMS}
Display: Resolution	See section „1.9.4.3. Resolution of the displayed values“		
Display: Accuracy ⁽⁴⁾	≤ 0.2% I_{Nom}	≤ 0.2% I_{Nom}	≤ 0.2% I_{Nom}
Compensation 10%→90% load	< 1.5 ms	< 1.5 ms	< 1.5 ms
Power regulation			
Adjustment range	0...320 W	0...320 W	0...320 W
Accuracy ⁽¹⁾ (at 23 ± 5°C)	< 1% P_{Nom}	< 1% P_{Nom}	< 1% P_{Nom}
Line regulation at ±10% ΔU_{AC}	< 0.05% P_{Nom}	< 0.05% P_{Nom}	< 0.05% P_{Nom}
Load regulation at 10-90% ΔU_{OUT} * ΔI_{OUT}	< 0.75% P_{Nom}	< 0.75% P_{Nom}	< 0.75% P_{Nom}
Display: Resolution	See section „1.9.4.3. Resolution of the displayed values“		
Efficiency ⁽³⁾	~ 93%	~ 93%	~ 93%

(1) Related to the nominal values, the accuracy defines the maximum deviation between an adjusted values and the true (actual) value.
Example: a 80 V model has min. 0.1% voltage accuracy, that is 80 mV. When adjusting the voltage to 5 V, the actual value is allowed to differ max. 80 mV, which means it might be between 4.92 V and 5.08 V.

(2) RMS value: LF 0...300 kHz, PP value: HF 0...20MHz

(3) Typical value at 100% output voltage and 100% power

(4) The display accuracy adds to the general accuracy, so the error (i.e. deviation) will be higher.

320 W	Model		
	PS 5040-20 A	PS 5080-10 A	PS 5200-04 A
Insulation			
Output (DC) to enclosure (PE)	DC minus: permanent max. ± 200 V DC plus: permanent max. ± 200 V + output voltage		
Input (AC) to output (DC)	Max. 2500 V, short-term		
Miscellaneous			
Cooling	Temperature controlled fans, front inlet, rear exhaust		
Ambient temperature	0..50°C		
Storage temperature	-20...70°C		
Humidity	< 80%, not condensing		
Standards	EN 61010, EN 61326		
Overvoltage category	2		
Protection class	1		
Pollution degree	2		
Operational altitude	< 2000 m		
Digital interfaces			
Featured	1x USB-B		
Galvanic isolation from device	Max. 1500 V DC		
USB specification	USB 2.0, socket type B, VCOM driver		
USB response time	max. 2 ms		
Terminals			
Rear side	Auxiliary DC output, AC input, remote sensing, USB-B		
Front side	Main DC output, ground (PE)		
Dimensions			
Enclosure (WxHxD)	200 x 87 x 303 mm		
Total (WxHxD)	200 x 94 x min. 337 mm		
Weight	~ 3 kg	~ 3 kg	~ 3 kg
Article number	05100303	05100304	05100305

640 W	Model		
	PS 5040-40 A	PS 5080-20 A	PS 5200-10 A
AC Input			
Input voltage	90...264 V AC	90...264 V AC	90...264 V AC
- with additional derating	90...150 V AC	90...150 V AC	90...150 V AC
Input connection	1ph,N,PE	1ph,N,PE	1ph,N,PE
Input frequency	50/60 Hz	50/60 Hz	50/60 Hz
Input fuse (internal)	MT 8 A	MT 8 A	MT 8 A
Leak current	< 3.5 mA	< 3.5 mA	< 3.5 mA
Power factor	~ 0.99	~ 0.99	~ 0.99
DC Output			
Max. output voltage U_{Max}	40 V	80 V	200 V
Max. output current I_{Max}	40 A	20 A	10 A
Max. output power P_{Max}	640 W	640 W	640 W
Overvoltage protection range	0...44 V	0...88 V	0...220 V
Overcurrent protection range	0...44 A	0...22 A	0...11 A
Overpower protection range	0...704 W	0...704 W	0...704 W
Temperature coefficient for set values Δ/K	Voltage / current: 100 ppm		
Voltage regulation			
Adjustment range	0...40.8 V	0...81.6 V	0...204 V
Accuracy ⁽¹⁾ (at 23 ± 5°C)	< 0.1% U_{Nom}	< 0.1% U_{Nom}	< 0.1% U_{Nom}
Line regulation at ±10% ΔU_{AC}	< 0.02% U_{Nom}	< 0.02% U_{Nom}	< 0.02% U_{Nom}
Load regulation at 0...100% load	< 0.05% U_{Nom}	< 0.05% U_{Nom}	< 0.05% U_{Nom}
Rise time 10...90% ΔU	Max. 30 ms	Max. 30 ms	Max. 30 ms
Display: Resolution	See section „1.9.4.3. Resolution of the displayed values“		
Display: Accuracy ⁽⁴⁾	≤ 0.2% U_{Nom}	≤ 0.2% U_{Nom}	≤ 0.2% U_{Nom}
Ripple ⁽²⁾	< 40 mV _{PP} < 5 mV _{RMS}	< 80 mV _{PP} < 10 mV _{RMS}	< 150 mV _{PP} < 30 mV _{RMS}
Remote sensing compensation	Max. 6% U_{Nom}	Max. 6% U_{Nom}	Max. 6% U_{Nom}
Current regulation			
Adjustment range	0...40.8 A	0...20.4 A	0...10.2 A
Accuracy ⁽¹⁾ (at 23 ± 5°C)	< 0.2% I_{Nom}	< 0.2% I_{Nom}	< 0.2% I_{Nom}
Line regulation at ±10% ΔU_{AC}	< 0.05% I_{Nom}	< 0.05% I_{Nom}	< 0.05% I_{Nom}
Load regulation at 0...100% ΔU_{OUT}	< 0.15% I_{Nom}	< 0.15% I_{Nom}	< 0.15% I_{Nom}
Ripple ⁽²⁾	< 60 mA _{RMS}	< 30 mA _{RMS}	< 12 mA _{RMS}
Display: Resolution	See section „1.9.4.3. Resolution of the displayed values“		
Display: Accuracy ⁽⁴⁾	≤ 0.2% I_{Nom}	≤ 0.2% I_{Nom}	≤ 0.2% I_{Nom}
Compensation 10%→90% load	< 1.5 ms	< 1.5 ms	< 1.5 ms
Power regulation			
Adjustment range	0...652.8 W	0...652.8 W	0...652.8 W
Accuracy ⁽¹⁾ (at 23 ± 5°C)	< 1% P_{Nom}	< 1% P_{Nom}	< 1% P_{Nom}
Line regulation at ±10% ΔU_{AC}	< 0.05% P_{Nom}	< 0.05% P_{Nom}	< 0.05% P_{Nom}
Load regulation at 10-90% ΔU_{OUT} * ΔI_{OUT}	< 0.75% P_{Nom}	< 0.75% P_{Nom}	< 0.75% P_{Nom}
Display: Resolution	See section „1.9.4.3. Resolution of the displayed values“		
Efficiency ⁽³⁾	~ 92%	~ 92%	~ 93%

(1) Related to the nominal values, the accuracy defines the maximum deviation between an adjusted values and the true (actual) value.

Example: a 80 V model has min. 0.1% voltage accuracy, that is 80 mV. When adjusting the voltage to 5 V, the actual value is allowed to differ max. 80 mV, which means it might be between 4.92 V and 5.08 V.

(2) RMS value: LF 0...300 kHz, PP value: HF 0...20MHz

(3) Typical value at 100% output voltage and 100% power

(4) The display accuracy adds to the general accuracy, so the error (i.e. deviation) will be higher.

640 W	Model		
	PS 5040-40 A	PS 5080-20 A	PS 5200-10 A
Insulation			
Output (DC) to enclosure (PE)	DC minus: permanent max. ± 200 V DC plus: permanent max. ± 200 V + output voltage		
Input (AC) to output (DC)	Max. 2500 V, short-term		
Miscellaneous			
Cooling	Temperature controlled fans, front inlet, rear exhaust		
Ambient temperature	0..50°C		
Storage temperature	-20...70°C		
Humidity	< 80%, not condensing		
Standards	EN 61010, EN 61326		
Overvoltage category	2		
Protection class	1		
Pollution degree	2		
Operational altitude	< 2000 m		
Digital interfaces			
Featured	1x USB-B		
Galvanic isolation from device	Max. 1500 V DC		
USB specification	USB 2.0, socket type B, VCOM driver		
USB response time	max. 2 ms		
Terminals			
Rear side	Auxiliary DC output, AC input, remote sensing, USB-B		
Front side	Main DC output, ground (PE)		
Dimensions			
Enclosure (WxHxD)	200 x 87 x 333 mm		
Total (WxHxD)	200 x 94 x min. 367 mm		
Weight	~ 4.3 kg	~ 4.3 kg	~ 4.3 kg
Article number	05100306	05100307	05100308

1.8.4 Views

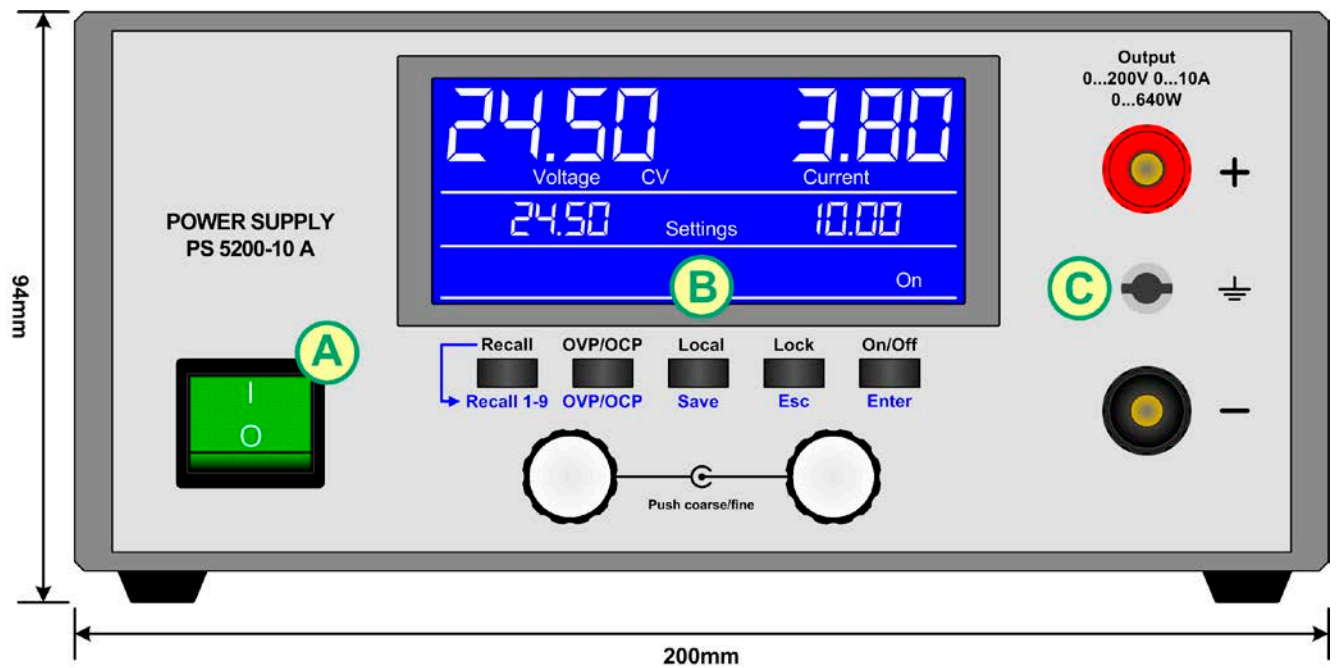

Figure 1 - Front side

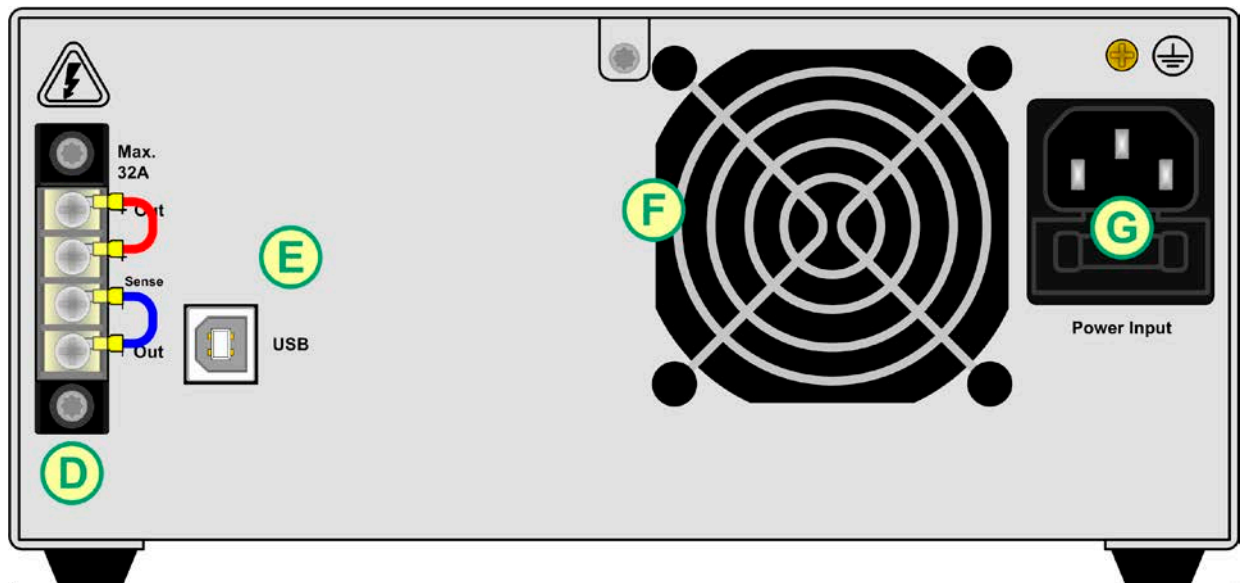

Figure 2 - Back side

- A - Mains switch
- B - Control panel
- C - DC output
- D - Exhausts
- E - Control interface (USB)
- F - Exhausts
- G - AC input socket with fuse

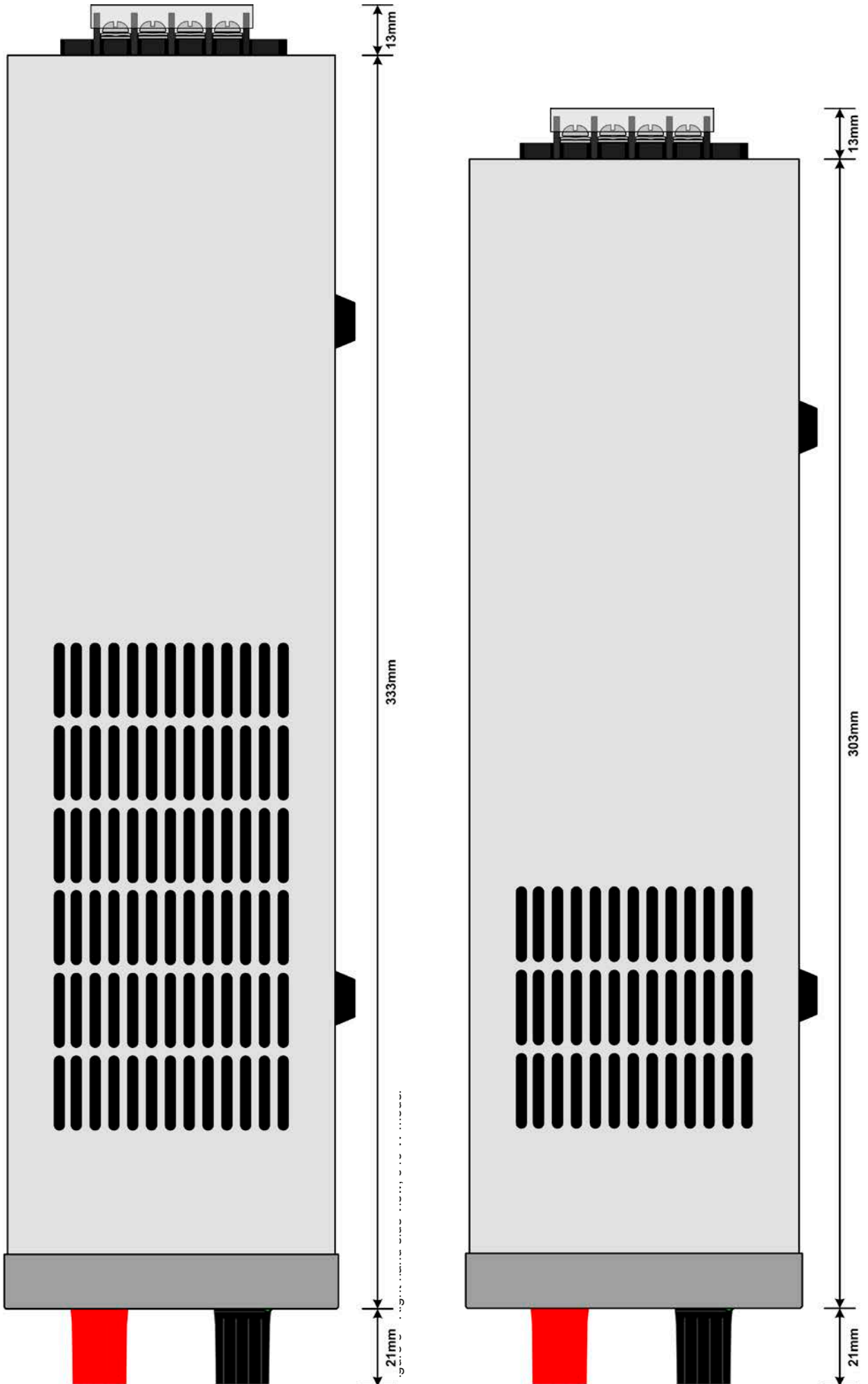

Figure 4 - Right hand side view, 160 W / 320 W model

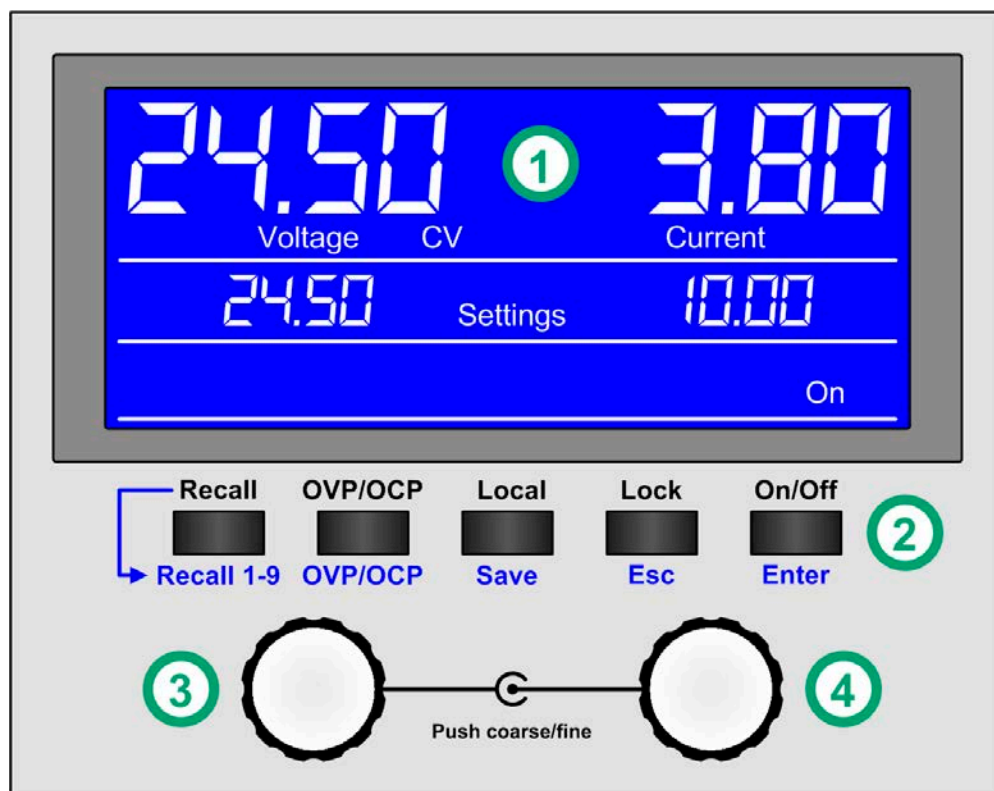

Figure 5 - Control Panel

Overview of the elements of the operating panel

For a detailed description see section „1.9.4. The control panel (HMI)“.

(1)	Display Used for indication of set values, actual values and status.
(2)	Button bank (5 buttons) Button Recall : Recalls stored presets (see 3.4.6) Button OVP/OCP : Switches to adjustment of OVP, OCP and OPP values Button Local : Activation / deactivation of the remote control inhibit (see 3.5.2) Button Lock : Activation / deactivation of the control panel lock (see 3.4.7) Button On/Off : Switches the DC output on or off (during manual control), acknowledges alarms
(3)	Left hand rotary knob, with button function Turn: adjusts the set value of voltage or power, as well as the values OVP and OPP Push: toggles between fine and coarse value adjustment
(4)	Right hand rotary knob, with button function Turn: adjusts the set value of current, as well as the values OCP Push: toggles between fine and coarse value adjustment

1.9 Construction and function

1.9.1 General description

The electronic DC laboratory power supplies of the PS 5000 A series are especially suitable for laboratories, workshops, school and other educational facilities due to their compact construction in a desktop enclosure.

For remote control using a PC or PLC the devices are provided as standard with an USB slot on the rear side. The interface are galvanically isolated from the DC output.

Series or parallel connection are possible. The DC output clamps on the front are suitable to connect soldered cable ends, spade lugs, cable end sleeves or 4mm Büschel plugs.

All models are controlled by microprocessors. These enable an exact and fast measurement and display of actual values.

1.9.2 Scope of delivery

1 x Power supply device

1 x 1.5 m power cord

1 x Socket adapter UK

1 x 1.8 m USB cable

1 x USB stick with software and documentation

1.9.3 Accessories

For these devices the following accessories are available:

<p>Safety adapters Art. no.: 10900114</p>	<p>Set of safety adapters (1x red, 1x black, gold covered, max. 32 A) for later mechanical installation onto the front side DC output connectors, in order to make them not exposed to touch. The adapters are supposed to receive 4mm safety plugs (normal or isolated).</p>	
--	---	--

1.9.4 The control panel (HMI)

The HMI (Human Machine Interface) consists of a display, two rotary knobs with button function and five pushbuttons.

1.9.4.1 Display

The blue, illuminated LCD display is divided into a three rows:

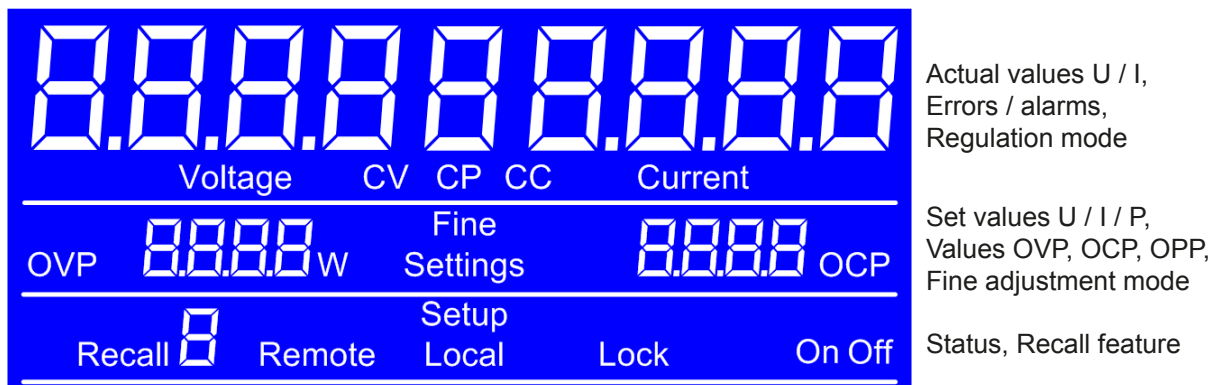

• Actual values area (upper row)

In normal operation the DC output values (actual values, large numbers, 7-segment) of voltage and current are displayed with four digits each. The display format of values is according to what's listed in 1.9.4.3. Below the actual values, it shows the actual regulation mode (CC, CV, CP) as long as the DC output is switched on.

• Set values area (middle row)

The set values of voltage and current are displayed here, which are adjustable with the left hand and right hand rotary knobs below the display, when operating the device manually. While doing so, the adjustment mode can be switched between fine and coarse by pushing any of the rotary knobs.

The left hand rotary knob is assigned either to the output voltage and related parameter OVP or the power and the related parameter OPP, whereas the right hand rotary knobs is always assigned to the output current and related parameter OCP. In remote control condition, the set values given from remote are displayed here.

This row furthermore indicates alarm conditions. See „3.6. Alarms and supervision“ for details.

General display and setting ranges:

Display	Unit	Range	Description
Actual voltage	V	0-125% U_{Nom}	Actual values of DC output voltage
Set value voltage	V	0-102% U_{Nom}	Set value for limiting the DC output voltage
Actual current	A	0.1-125% I_{Nom}	Actual value of DC output current
Set value current	A	0-102% I_{Nom}	Set value for limiting the DC output current
Set value power	W	0-102% P_{Nom}	Set value for limiting the DC output power
Protection settings	none or W	0-110% Nominal val.	OVP, OCP, OPP

• Status area (lower half, middle)

This row indicates various statuses:

Display	Description
Recall 1-9	Number of the currently selected preset in recall mode (see 3.4.6)
Remote	The device is under remote control via USB interface
Setup	The device in setup menu, in this case power set value adjustment mode
Lock	The control panel (HMI) is locked (see 3.4.7)
Local	The device has been locked by the user explicitly against remote control
On / Off	Indicates the state of the DC output
Fine	Fine adjustment mode currently active (temporary, not stored, default: not active)

1.9.4.2 Rotary knobs



As long as the device is in manual operation, the two rotary knobs are used to adjust set values. For a detailed description of the individual functions see section „3.4. Manual operation“. Both rotary knobs have an additional pushbutton function to switch the adjustment mode between fine (display show **Fine**) and coarse adjustment. Both knobs can switch both modes. See 3.4.3 for details.

Coarse mode means to always increment or decrement any value by 1, while fine mode is connected to the last decimal place (see table in 1.9.4.3).

1.9.4.3 Resolution of the displayed values

All adjustable values have 4 digits. The number of decimal places depends on the device model. Actual and set values related to the same physical unit always have the same number of digits.

Adjustment resolution and number of digits of set values in the display:

Voltage, OVP			Current, OCP			Power, OPP		
Nominal	Digits	Increment	Nominal	Digits	Increment	Nominal	Digits	Increment
40 V / 80 V	4	0.01 V	2 A / 4 A / 5 A	4	0.001 A	160 W	4	0.1 W
200 V	4	0.1 V	10 A / 20 A	4	0.01 A	320 W	4	0.1 W
			40 A	4	0.01 A	640 W	4	0.1 W



In manual operation every set value can be set in the increments given above. In this case the actual output values set by the device will lie within percentage tolerances as shown in the technical data sheets. These will influence the actual values.

1.9.5 USB port (rear side)

The USB port on the back side of the device is provided for communication with the device and for firmware updates. The included USB cable can be used to connect the device to a PC (USB 2.0, USB 3.0). The driver is delivered on the included USB stick or is available as download and installs a virtual COM port. Details for remote control can be found in external documentation, a general programming guide, on the web site of the manufacturer or on the included USB stick.

The device can be addressed via the USB port using the international standard ModBus protocol.

1.9.6 Sense connector (remote sensing)

If the output voltage has to be dependant on the consumer location rather than the DC output of the power supply, then the input “Sense” can be connected to the consumer where the DC connection is made. This compensates, up to a certain limit, the voltage difference between the power supply output and the consumer, which is caused by the high current through the load cables. The maximum possible compensation is given in the technical data.

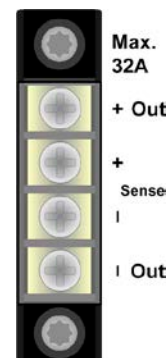

2. Installation & commissioning

2.1 Storage

2.1.1 Packaging

It is recommended to keep the complete transport packaging for the lifetime of the device for relocation or return to the manufacturer for repair. Otherwise the packaging should be disposed of in an environmentally friendly way.

2.1.2 Storage

In case of long term storage of the equipment it is recommended to use the original packaging or similar. Storage must be in dry rooms, if possible in sealed packaging, to avoid corrosion, especially internal, through humidity.

2.2 Unpacking and visual check

After every transport, with or without packaging, or before commissioning, the equipment should be visually inspected for damage and completeness using the delivery note and/or parts list (see section „1.9.2. Scope of delivery“). An obviously damaged device (e.g. loose parts inside, damage outside) must under no circumstances be put in operation.

2.3 Installation

2.3.1 Preparation

Mains connection for a PS 5000 A series device is done via the included 1.5 meters long 3 pole mains cord. It is required to operate the device with this or a similar cord which features a ground conductor. The ground is important for safety and radio interference suppression.

When extending the power cord with extension cable(s) or power strip(s), it is important not to interrupt the ground connection.

2.3.2 Installing the device



- Select the location for the device so that the connection to the load is as short as possible.
- Leave sufficient space behind the equipment, minimum 30cm, for ventilation.

The device supposed to be operated in horizontal position. However, installing it in racks or cabinets is possible if protective measure are not made invalid or are interrupted and ventilation slots are not impeded.

Acceptable and unacceptable installation positions:

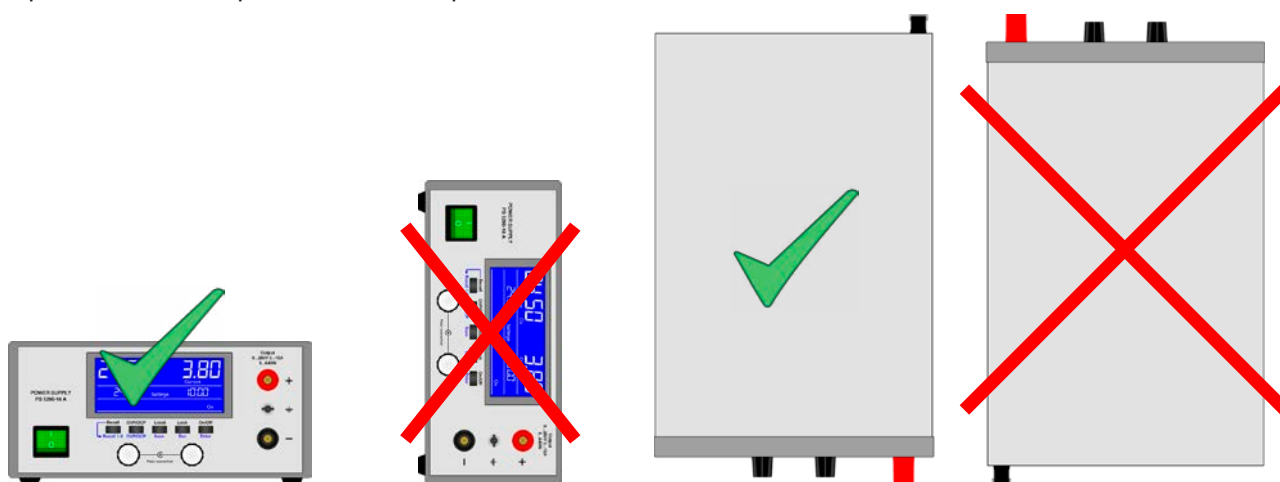

Standing surface

2.3.3 Connection to AC supply



- The device can be connected to any wall socket or power strip, as long as those feature a ground conductor (PE)
- When connecting the device to a power strip, along with other electric devices, it is important to consider the total power consumption of all devices on the strip, so that the maximum current (power ÷ minimum voltage) does not exceed the definition for the wall socket, the power strip and/or main distribution

The device is delivered with a 3 pole power cord.

Nominal power	Default connection rating	Connection type
160 W	230 V, 50 Hz, ~2 A	Wall socket
320 W	230 V, 50 Hz, ~4 A	Wall socket
640 W	230 V, 50 Hz, ~8 A	Wall socket

2.3.4 Connection to DC loads

The device features two DC output connectors. The main output is on the front side and the auxiliary output on the rear side. While the main output is defined for the rated output current, the aux output can only be used up to 32 A.



For the connection of loads or parallel connection of multiple units, following applies:

- **With the 40 A model, it is not allowed to connect a load to the auxiliary output which could permanently draw more than 32 A, unless the current is limited to 32 A by current set value**
- **It is not allowed to connect multiple units in parallel on their auxiliary outputs and then connecting the load on one of the main outputs on the front, unless the total current does not exceed 32 A**
- **With the 40 A model, it is not allowed to use and plug 4mm Büschel plugs on the main DC output when working with loads that can draw more 35 A, unless the output current is limited to 35 A by current set value**

Both DC outputs are **not** protected by a fuse. The cross section of the connection cable is determined by the current consumption, cable length and ambient temperature.

For cables **up to 1.5 m** and average ambient temperature up to 50°C, we recommend:

up to **10 A**: 0,75 mm² (AWG18) up to **20 A**: 2.5 mm² (AWG12) up to **40 A**: 6 mm² (AWG8)

per lead (multi-conductor, insulated, openly suspended). Single cables of, for example, 6 mm² may be replaced by e.g. 2x 2.5 mm² etc. If the cables are long then the cross section must be increased to avoid voltage loss and overheating.

2.3.4.1 Possible methods of connections on the main DC output

The main output on the front is of type screw & plug and can be used with:

- 4 mm system plugs (Büschel) for max. 35 A
- Spade lugs (4 mm or bigger)
- Soldered cable ends
- Cable end sleeves (using the cross hole, 1.5 mm, max. 10 A)

2.3.4.2 Possible methods of connections on the auxiliary DC output

The auxiliary output on the rear is limited for max. 32 A, is of type screw terminal and can be used with:

- Soldered cable ends
- Cable end sleeves (various sizes)
- Spade lugs (4 mm)



Dangerous voltage!

For safety reasons and when using cable end sleeves, plugs or cable lugs on the main DC output or auxiliary DC output you must use insulated types or install additional protection measures against touch.

2.3.5 Grounding of the DC output

Individually operated devices can always be grounded from the DC minus or DC plus pole, i.e. one of both can be directly connected to PE.

However, when using series connection restrictions apply, because when grounding the DC plus pole of the series connection, the DC minus poles of all units are shifted in negative direction against PE and this is only allowed up to 200 V DC for any DC minus.

Thus, in case it is required to ground the DC plus pole, it is not allowed to connect 200 V models in series resp. when using 80 V units, not allowed to connect more than two units in series.

Furthermore, following has to be taken into consideration:



When grounding any of the DC output poles it is important to check if any pole of the load or any signal on a controlling application (PC, PLC) is also grounded. This could lead to a short circuit or bypass the galvanic isolation of the USB interface!

2.3.6 Connection of remote sensing

In order to compensate, to a certain degree, the voltage loss in a DC cable, the device provides the possibility to connect the remote sensing input "Sense" to the load. The device recognizes the remote sensing mode automatically and regulates the output voltage (only in CV operation) at the load rather than at its own DC output.

In the technical specifications (see section „1.8.3. Specific technical data“) the level of maximum possible compensation is given. If that is insufficient, the cable cross section must be increased.



- Remote sensing is only effective during constant voltage operation (CV) and for other regulation modes the sense input should be disconnected, if possible, because connecting it generally increases the oscillation tendency.
- The cross section of the sense cables is noncritical. However, it should be increased with increasing cable length. Recommendation: for cables up to 5 m use at least 0.5 mm²
- Sense cables should be twisted and laid close to the DC cables to damp oscillation. If necessary, an additional capacitor should be installed at the load/consumer to eliminate oscillation
- The sense cables must be connected + to + and - to - at the load, otherwise both systems may be damaged

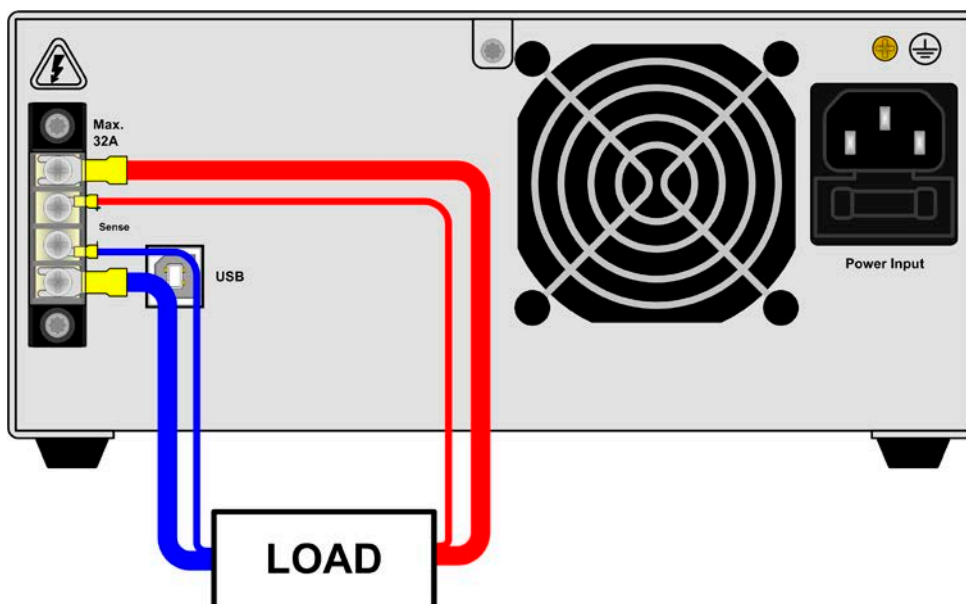

Figure 6 - Example for remote sensing wiring when using the aux output

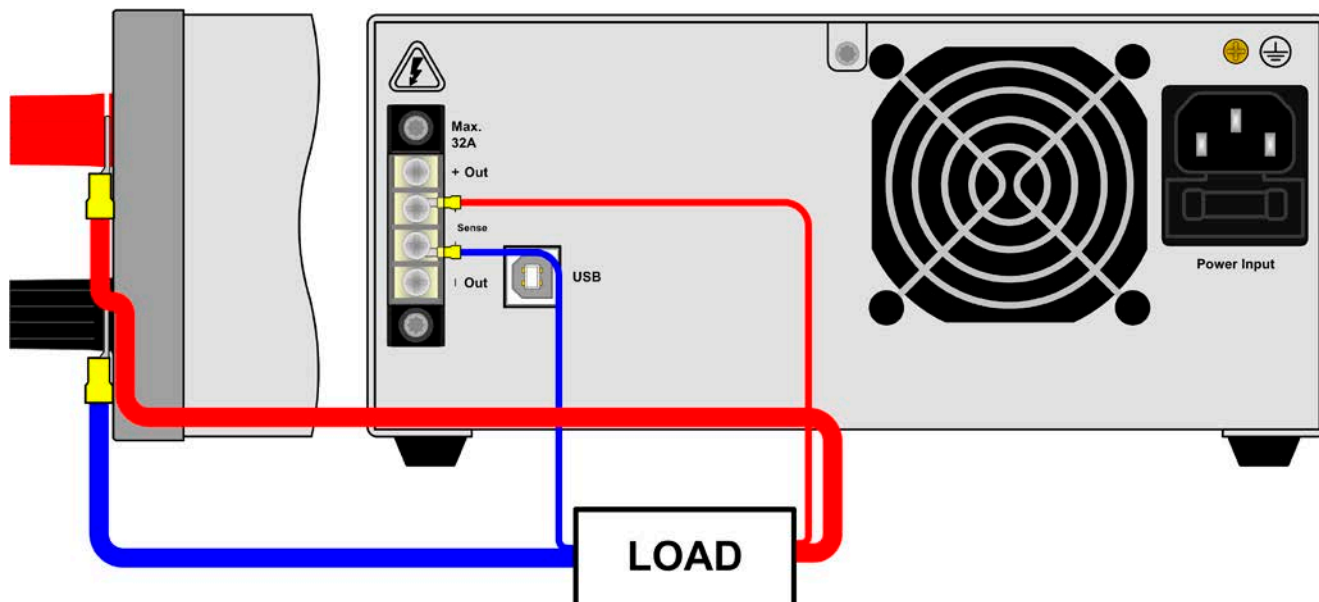

Figure 7 - Example for remote sensing wiring when using the main output

2.3.7 Connecting the USB port (rear side)

In order to remotely control the device via this port, connect the device with a PC using the included USB cable and switch the device on.

2.3.7.1 Driver installation (Windows)

On the initial connection with a PC the operating system will identify the device as new hardware and will try to install a driver. The required driver is for a Communications Device Class (CDC) device and is usually integrated in current operating systems such as Windows 7 or 10. But it is strongly recommended to use and install the included driver installer (on USB stick) to gain maximum compatibility of the device to our softwares.

In case the USB stick is not available, the driver can also be obtained from our website (**Service -> Downloads**).

2.3.7.2 Driver installation (Linux, MacOS)

We cannot provide drivers or installation instructions for these operating systems. Whether a suitable driver is available is best carried out by searching the Internet.

2.3.7.3 Alternative drivers

In case the CDC drivers described above are not available on your system, or for some reason do not function correctly, commercial suppliers can help. Search the Internet for suppliers using the keywords "cdc driver windows" or "cdc driver linux" or "cdc driver macos".

2.3.8 Initial commission

For the first start-up after purchasing and installing the device, the following procedures have to be executed:

- Confirm that the connection cables for DC to be used are of a satisfactory cross section
- Check that the default settings for set values, safety and monitoring functions and communication are suitable for your application and change them where necessary, as described in the manual
- In case of remote control via PC, read the additional documentation for interfaces and software

2.3.9 Commission after a firmware update or a long period of non-use

In case of a firmware update, return of the equipment following repair or a location or configuration change, similar measures should be taken to those of initial start up. Refer to „2.3.8. *Initial commission*“.

Only after successful checking of the device as listed may it be operated as usual.

3. Operation and application

3.1 Personal safety



- In order to guarantee safety when using the device, it is essential that only persons operate the device who are fully acquainted and trained in the required safety measures to be taken when working with dangerous electrical voltages
- Whenever the load and DC output connection are being re-configured, the device should be disconnected from the mains, not only the DC output switched off!

3.2 Operating modes

A power supply is internally controlled by different control or regulation circuits, which shall bring voltage, current and power to the adjusted values and hold them constant, if possible. These circuits follow typical laws of control systems engineering, resulting in different operating modes. Every operating mode has its own characteristics which is explained below in short form.

3.2.1 Voltage regulation / Constant voltage

Voltage regulation is also called constant voltage operation (CV).

The DC output voltage of a power supply is held constant on the adjusted value, unless the output current or the output power according to $P = U_{OUT} * I_{OUT}$ reaches the adjusted current or power limit. In both cases the device will automatically change to constant current or constant power operation, whatever occurs first. Then the output voltage can not be held constant anymore and will sink to a value resulting from Ohm's law.

While the DC output is switched on and constant voltage mode is active, then the condition "CV mode active" will be indicated on the display by the abbreviation **CV** and can also be read as a status via digital interface.

3.2.2 Current regulation / constant current / current limiting

Current regulation is also known as current limitation or constant current mode (CC).

The DC output current is held constant by the power supply, once the output current to the load reaches the adjusted limit. Then the power supply automatically switches. The current flowing from the power supply is determined by the output voltage and the load's true resistance. As long as the output current is lower than the adjusted current limit, the device will be either in constant voltage or constant power mode. If, however, the power consumption reaches the set maximum power value, the device will switch automatically to power limiting and sets the output current according to $I_{MAX} = P_{SET} / U_{IN}$, even if the maximum current value is higher. The current set value, as determined by the user, is always an upper limit only.

While the DC output is switched on and constant current mode is active, then the condition "CC mode active" will be indicated on the display by the abbreviation **CC** and can also be read as a status via digital interface.

3.2.3 Power regulation / constant power / power limiting

Power regulation, also known as power limiting or constant power (CP), keeps the DC output power of a power supply constant if the current flowing to the load in relation to the output voltage and the resistance of the load reaches the adjusted power value according to $P = U * I$ resp. $P = U^2 / R$. The power limitation then regulates the output current according to $I = \sqrt{P / R}$, where R is the load's resistance.

Power limiting operates according to the auto-range principle such that at lower output voltages higher current flows and vice versa in order to maintain constant power within the range P_N (see diagram to the right)

While the DC output is switched on and constant power mode is active, then the condition "CP mode active" will be shown on the display by the abbreviation **CP** and can also be read as a status message via digital interface.

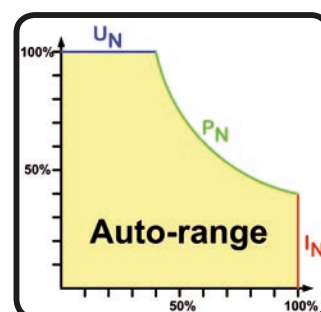

3.3 Alarm conditions



This section only gives an overview about device alarms. What to do in case your device indicates an alarm condition is described in section „3.6. Alarms and supervision“.

As a basic principle, all alarm conditions are signalled optically (in the display) and as a readable status via the digital interface. With most alarms occurring, the DC output of the device is switched off.

3.3.1 Power Fail (only with 640 W models)

Power Fail (PF) indicates an alarm condition which may have various causes:

- AC input voltage too low (mains undervoltage, mains failure)
- Defect in the input circuit (PFC)



Switching off the device by the mains switch can not be distinguished from a mains blackout and thus the device will signalise a PF alarm every time the device is switched off. This can be ignored.

3.3.2 Overtemperature

An overtemperature alarm (OT) can occur if an excess temperature inside the device causes to stop the device from supplying power. As soon as the device has cooled down, it will automatically continue to supply power, unless the user has intervened by switching off the DC output in the meantime.



An OT alarm has a lower priority than an OV alarm (overvoltage). If an OV alarm occurs during an OT alarm, then the it will overwrite the alarm indication.

3.3.3 Overvoltage protection

An overvoltage alarm (OVP) will switch off the DC output and can occur if:

- the power supply itself, as a voltage source, generates an output voltage higher than set for the overvoltage alarm limit (OVP, 0...110% U_{Nom}) or the connected load somehow returns voltage higher than set for the overvoltage alarm limit
- the OV threshold has been adjusted too close above the output voltage. If the device is in CC mode and if it then experiences a negative load step, it will make the voltage rise quickly, resulting in a voltage overshoot for a short moment which can already trigger the OVP

This function serves to warn the user of the power supply acoustically or optically that the device probably has generated an excessive voltage which could damage the connected load application.



The device is not fitted with protection from external overvoltage.

3.3.4 Overcurrent protection

An overcurrent alarm (OCP) will switch off the DC output and can occur if:

- The output current in the DC output reaches the adjusted OCP limit.

This function serves to protect the connected load application so that this is not overloaded and possibly damaged due to an excessive current.

3.3.5 Overpower protection

An overpower alarm (OPP) will switch off the DC output and can occur if:

- the product of the output voltage and output current in the DC output reaches the adjusted OPP limit.

This function serves to protect the connected load application so that this is not overloaded and possibly damaged due to an excessive power consumption.

3.3.6 Remote sensing

An alarm that is indicated only to make the user notice, that

- either the remote sensing is not correctly connected or interrupted (sense bridges on rear, cables to load).
- the max. compensation is reached.

3.4 Manual operation

3.4.1 Switching the device on

The device should, as far as possible, always be switched on using the toggle switch on the front of the device. Alternatively this can take place using an external cutout (contactor, circuit breaker) of suitable current capacity.

After switching on and a certain start-up time, the device will be ready for use. It also restores the last condition of the DC output like it was when switching the device off the last time, so either on or off. All set values are always saved and restored.

3.4.2 Switching the device off

On switch-off the last output condition and the most recent set values are saved. The DC output is immediately switched off and a power fail error PF (only 640 W models) will be indicated, but can be ignored here, and after a short while the device will be completely powered off.

3.4.3 Manual adjustment of set values

Adjusting the set values of voltage, current and power is the fundamental operating possibility of a power supply and hence the two rotary knobs on the front of the device are usually assigned to voltage (left-hand knob) and current (right-hand knob).

The manual adjustment of the set values can only be done while the device is not in a different mode, like adjustment mode for OVP/OCP values. See figure to the right. In normal operation mode, the middle row shows the set values.

The power set value is not directly adjustable from here.

The control panel lock (see 3.4.7) can block the user from adjusting set values.

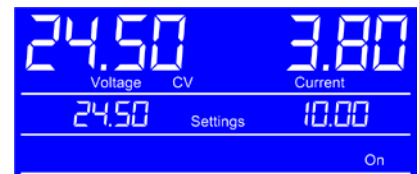

► How to adjust voltage and current manually

1. In normal operation (see example screenshot above), rotate the left-hand knob to adjust voltage and the right-hand knob to adjust current, no matter if the DC output is switched on or off.
2. While adjusting values, you can push any of the knobs to switch between fine and coarse adjustment of values. See below.

► How to switch between fine and coarse value adjustment

1. Coarse adjustment mode is default after the unit has been powered. It will increment or decrement a value by 1. You can switch to fine adjustment mode anytime by shortly pushing any of the rotary knobs. This mode is indicated in the displays as shown in the example screenshot to the right.



► How to adjust power manually

1. In normal operation (see example screenshot above), push **both** rotary knobs **simultaneously**.
2. The display should switch to setup mode, in this case for power value adjustment. See example screenshot to the right.
3. Adjust the indicated power value (unit W) with the left-hand rotary knob, like when adjusting voltage. Switching between fine and coarse adjustment as described above. In case the DC output is switched on, the adjusted values immediately becomes effective.
4. Leave the power adjustment mode by pushing **both** rotary buttons again and simultaneously.



Adjusting set value always submits the value to the power stage immediately, no matter if the DC output is switched on or off.

The set values of voltage and current are part of the recall sets (see 3.4.6), the power set value is not.

3.4.4 Manually configure protections

Along with adjustable set values, the device offers excess protections related to voltage, current and power, which are intended to protect the possibly expensive load hardware. They are configurable in form of adjustable thresholds that the device supervises and in case of excess it will switch off the DC output. Those protections are OVP (overvoltage protection), OCP (overcurrent protection) and OPP (overpower protection). Any of these values is adjustable between 0% and 110% of the related nominal value.

The thresholds are manually adjustable at any time. There is a dedicated mode OVP/OCP which can be accessed via the equally named pushbutton.

The control panel lock (see 3.4.7) can block the user from adjusting the thresholds.

► How to manually adjust the thresholds of OVP and OCP

1. In normal operation, push button **OVP/OCP** once to enter OVP/OCP adjustment mode
2. The display switches to show the OVP and OCP thresholds, as indicated in the example screenshot to the right.
3. Adjust those values as desired, like when adjusting voltage or current. The adjustment range here is 10% bigger so the thresholds can also be adjusted above the maximum voltage or current.
4. Leave this adjustment mode by pressing button **OVP/OCP** again.



► How to manually adjust the threshold of OPP

1. In normal operation, press button **OVP/OCP** once. After this, push **both** rotary knobs **simultaneously** to enter OPP adjustment mode. This mode can also be reached by doing it vice versa, means first to push both knobs and then pushbutton **OVP/OCP**.
2. The display switches to show the OPP threshold (unit W), as indicated in the example screenshot to the right.
3. Adjust the value like you would adjust the power set value. The adjustment range here is 10% bigger so the threshold can also be adjusted above the maximum power.
4. Leave this adjustment mode again by pressing button **OVP/OCP** and then pushing both rotary knobs simultaneously. Or do it vice versa.

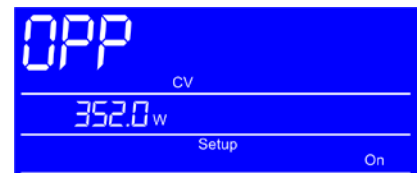

With the DC output being switched on, the thresholds immediately become effective while adjusting and they might generate an alarm, in case any of these three thresholds is adjusted lower than the related set value.

The value OVP and OCP are part of the recall sets (see 3.4.6), the value OPP is not.

3.4.5 Switching the DC output on or off

The DC output of the device can be manually or remotely switched on and off. Switching it on can be restricted in manual operation by the control panel being locked (see 3.4.7), whereas switching it off manually is always possible for safety reasons, unless the device is in remote control.

► How to manually switch the DC output on or off

1. As long as remote control is not active, push button **On/Off** anytime to switch the DC output off, in case it is on. As long as the control panel (HMI) is not locked, press the button anytime to switch the DC output on, in case it is off.
2. The button toggles between the two states, as long as a change is not restricted by an alarm or the device being in "remote" mode. The current condition is displayed as "On" or "Off".

► How to remotely switch the DC output on or off via the digital interface

1. See the external documentation "Programming Guide ModBus & SCPI" if you are using custom software, or refer to the external documentation of LabView VIs or other software provided by the manufacturer.

3.4.6 Recall feature

The recall feature is intended to easily recall presets of often used set values (U, I) and protection thresholds (OVP, OCP), except the power set value and OPP threshold. With this, the user can switch between the presets without having to adjust every time again. There are 9 presets for custom definition.

Saving and recalling the presets can only be done while the DC output is switched off.

► How to adjust and save a preset

1. In case the DC output is still on, switch it off by pushing button **On/Off**.
2. Push button **Recall** once to enter recall mode. The display switches to show the settings of the first preset, as stored in it: U (left) and I (right). See example screenshot to the right.
3. If required, push button **Recall 1-9** (blue printing) again to select another preset. After **Recall 9**, the recall mode is left.
4. Adjust the preset values for voltage and current here and as desired. In order to switch to adjustment mode for protections OVP and OCP, which are part of a preset, push button **OVP/OCP** and the display will switch to display the OVP/OCP thresholds stored in the preset. See example screenshot to the right.
5. Save the preset by pushing button **Save** (blue printing) once or discard the changes with button **Esc** (blue printing). When discarding, the former values won't be overwritten. After using any of these two buttons, recall mode is left.

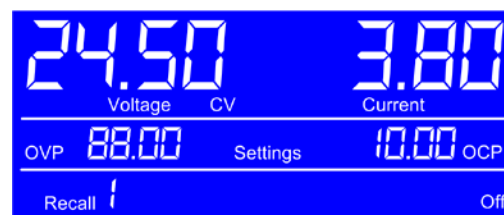

After the desired number of presets have been defined to custom needs, they can be recalled and used.

► How to recall and apply a preset

1. In case the DC output is still on, switch it off by pushing button **On/Off**.
2. Push button **Recall** once to enter recall mode. The display switches to show the settings of the first preset, as stored in it: U (left) and I (right). See example screenshot to the right.
3. If required, push button **Recall 1-9** (blue printing) again to select another preset. After **Recall 9**, the recall mode is left.
4. Push button **Enter** (blue printing) to submit the values stored in the preset, overwriting the currently active output settings. The four values either become immediately effective (OVP, OCP) or after switching the DC output on again (U, I).

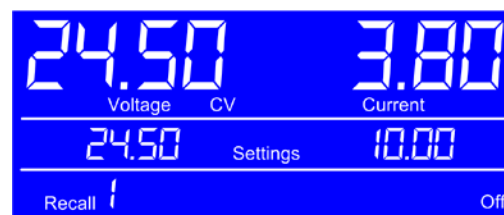

3.4.7 Control panel (HMI) lock

In order to prevent accidental misadjustment of a set value, the control panel (buttons, knobs) can be lock in manual operation, so that no status or value can be changed until the lock is deactivated again. If the lock has been activated while the DC output is switched on, only button **On/Off** can be used once to switch off the output in case of emergency.

► How to lock the control panel

1. Push button **Lock** anytime and in every adjustment mode. The display will indicate the lock as displayed in the example screenshot to the right.



Lock condition remains until you deactivate it by pushing button **Lock** again, even if you would switch to remote control in-between and return from it, or switching the device off. The lock is not saved when switching the device off.

3.5 Remote control

3.5.1 General

Remote control is principally possible via the built-in USB interface. Important here is that the device never automatically changes into remote control mode, for example by receiving the first command. It has to be switched to remote control by the user and by using an explicit command. This can be denied by the device in case remote control is not allowed due to “**Local**” mode being active. See further description below.

However, status monitoring and reading of values are always possible.

3.5.2 Control locations

Control locations are those locations from where the device can be controlled. Essentially there are two: at the device (manual operation) and outside (remote control). The following locations are defined:

Displayed location	Description
-	If neither of the other locations is displayed then manual control is active and access from the digital interface is allowed. This control location is not explicitly displayed
Remote	Remote control via digital interface is active
Local	Remote control is locked, only manual operation is allowed.

Remote control may be allowed or inhibited using button **Local**. In inhibited condition the status “**Local**” will be displayed (lower row) of the display. See example screenshot to the right.

Activating the inhibit can be useful if the device is remotely controlled by software or some electronic device, but it is required to make adjustments at the device or deal with emergency, which would not be possible remotely.



Activating condition “**Local**” causes the following:

- If remote control via the digital interface is active (“**Remote**”), then remote control is immediately terminated and must be reactivated at the PC once “**Local**” is no longer active
- If manual operation is used, remote control from a PC can't be activated

3.5.3 Remote control via the digital interface

3.5.3.1 General

The USB interface requires no additional setup for operation. Via the digital interface primarily the set values (voltage, current, power) and device conditions can be set and monitored. Furthermore, various other functions are supported (protections, recall feature) as described in separate programming documentation.

Changing to remote control will retain the last set values for the device until these are changed. Thus a simple voltage control by setting a target value is possible without changing any other values.

3.5.3.2 Programming

The devices supports ModBUS RTU protocol. Programming details for the USB interface and the Modbus protocol are to be found in the documentation “Programming Guide ModBus & SCPI” which is supplied on the included USB stick or which is available as download from the manufacturer's website.

3.6 Alarms and supervision

3.6.1 Definition of terms

Device alarms (see „3.3. Alarm conditions“) are defined as conditions like overvoltage or overtemperature, which can occur in relation to protection feature with partly adjustable thresholds.

The alarms are always indicated in the front display and are as well available as readable status via digital interface when controlling or just monitoring remotely.

3.6.2 Device alarm handling

A device alarm incident will lead to DC output switch-off in most cases. The alarm must always be acknowledged, which can only happen if the cause of the alarm is not persistent anymore. Ways to acknowledge:

- in manual control by switching the DC output on again or just by pushing button **On/Off**.
- in digital remote control by sending a specific command to acknowledge alarms (ModBus), usually after the actual alarm has been recorded.

Some device alarms are configurable by adjusting a threshold. This is described in „3.4.4. Manually configure protections“:

Alarm	Meaning	Description	Range
OVP	OverVoltage Protection	Triggers an alarm if the DC output voltage reaches the defined threshold. This can be caused by the device being faulty or by an external source. The DC output will be switched off.	0 V...1.1*U _{Nom}
OCP	OverCurrent Protection	Triggers an alarm if the DC output current reaches the defined threshold. The DC output will be switched off.	0 A...1.1*I _{Nom}
OPP	OverPower Protection	Triggers an alarm if the DC output power reaches the defined threshold. The DC output will be switched off.	0 W...1.1*P _{Nom}

These device alarms can't be configured and are based on hardware:

Alarm	Meaning	Description
PF	Power Fail	Only available with 640 W models. AC supply over- or undervoltage. Triggers an alarm if the AC supply is out of specification or when the device is cut from supply, for example when switching it off with the power switch. The DC output will be switched off.
OT	OverTemperature	Triggers an alarm if the internal temperature reaches a certain limit. The device will also stop supplying power for an uncertain time and until it has cooled down again, in order to automatically continue supply afterwards.
SE	Sense	Remote sense error. Triggers an alarm in case the remote sense connection to the load or the sense bridges on the rear is interrupted (bridges have to be placed when remote sense is not used) or in case the remote has reached the maximum possible compensation. This can only happen with the DC output being switched on. If the alarm occurs, the DC output is not switched off. This is just to inform the user that the voltage on the load can not be regulated to the adjusted output voltage.

3.7 Other applications

3.7.1 Parallel operation

Multiple devices of same kind and model can be connected in parallel in order to create a system with higher total current and hence higher power.

There is no additional support from hardware or software for this kind of operation, regarding voltage regulation and current balancing. Every unit would have to be adjusted like a standalone device, either manually or remotely.

In this operation mode, some important things have to be noticed and adhered:



- **Never connect models with different max. output voltage**
- **When connecting models with 40 A max. current on the auxiliary output, a max. of 32 A per unit must not be exceeded**
- **When connecting multiple units on their auxiliary output, the total current must not be drawn from any of the main outputs on the front in case it can exceed 32 A**

3.7.1.1 Wiring the DC outputs

The DC outputs (main output, aux output or both) of every unit in the parallel operation is simply connected to the next unit using cables with cross section according to the maximum current and with short as possible length.

3.7.2 Series connection

Series connection of two or multiple devices is basically possible. But for reasons of safety and isolation, some restrictions apply:



- **Both, negative (DC-) and positive (DC+) output poles, are coupled to PE via type X capacitors, thus none of the DC minus pole of any unit in the series connection must have a potential of >200 V against ground (PE)!**
- **Remote sensing must not be wired to the load, only the sense bridges on the aux output (rear) are allowed!**
- **Series connection is only allowed with devices of the same kind and model, i.e. power supply with power supply, like for example PS/PSI 5080-10 A with PS 5080-10 A**

Series connection is not supported by the software and hardware of the device. It means, all units have to be controlled separately regarding set values and DC output status, no matter if manual or remote control.

Due to the max. potential shift of 200 V DC against ground (PE), a max. of two 200 V models or a max. of four 80 V models are allowed in series connection.

3.7.3 Operation as battery charger

A power supply can be used as a battery charger, but with some restrictions, because it misses a battery supervision and a physical separation from the load in form of a relay or contactor, which is featured with some real battery chargers as a protection.

Following has to be considered:

- **No false polarity protection inside!** Connecting a battery with false polarity will damage the power supply severely, even if it is not powered.
- **All models of this series have an internal circuit, i.e. base load, for faster discharge of voltage when switching the DC output off or ramping voltage down.** This base load would, more or less slowly, discharge the battery while the DC output is switched off, means while it is not charging. This would, however, not occur when the power supply is not powered at all. It is thus recommended to leave the DC output switched on as long as the battery is connected (equals to trickle charge) and only switch it off for connecting/disconnecting a battery.

4. Service and maintenance

4.1 Maintenance / cleaning

The device needs no maintenance. Cleaning may be needed for the internal fans, the frequency of cleanse is depending on the ambient conditions. The fans serve to cool the components which are heated by the inherent power loss. Heavily dirt filled fans can lead to insufficient airflow and therefore the DC output would switch off too early due to overheating or possibly lead to defects.

Cleaning the internal fans can be performed with a vacuum cleaner or similar. For this the device needs to be opened.

4.2 Fault finding / diagnosis / repair

If the equipment suddenly performs in an unexpected way, which indicates a fault, or it has an obvious defect, this can not and must not be repaired by the user. Contact the supplier in case of suspicion and elicit the steps to be taken.

It will then usually be necessary to return the device to the supplier (with or without guarantee). If a return for checking or repair is to be carried out, ensure that:

- the supplier has been contacted and it is clarified how and where the equipment should be sent.
- the device is in fully assembled state and in suitable transport packaging, ideally the original packaging.
- a fault description in as much detail as possible is attached.
- if shipping destination is abroad, the necessary customs papers are attached.

4.2.1 Replacing a defect mains fuse

The device is protected by one 5x20 mm fuse (T16 A, 250 V) which is located on the rear of the device, inside a fuse holder. To replace the fuse, the device is not required to be opened. Just remove the power cord and open the fuse holder in the AC input socket with a flat screw driver. The replacement fuse must be of same value and type.

4.3 Firmware updates

The firmware of the device, if necessary, is updated via the USB port on the rear side. For this a software called EA Power Control is required. It is included on the USB stick which is delivered with the device or available from the manufacturer's website. The required firmware update file is only available on the website in the **Service -> Downloads** section. Further instructions are included in the update tool's documentation.

5. Contact and support

5.1 Repairs

Repairs, if not otherwise arranged between supplier and customer, will be carried out by the manufacturer. For this the device must generally be returned to the manufacturer. No RMA number is needed. It is sufficient to package the equipment adequately and send it, together with a detailed description of the fault and, if still under guarantee, a copy of the invoice, to the following address.

5.2 Contact options

Questions or problems with operation of the device, use of optional components, with the documentation or software, can be addressed to technical support either by telephone or e-Mail.

Address	e-Mail	Telephone
EA Elektro-Automatik GmbH Helmholtzstr. 31-33 41747 Viersen Germany	All issues: ea1974@elektroautomatik.de Support: support@elektroautomatik.de	Switchboard: +49 2162 / 37850 Support: +49 2162 / 378566



Elektro-Automatik

EA-Elektro-Automatik GmbH & Co. KG
Development - Production - Sales

Helmholtzstraße 31-33
41747 Viersen
Germany

Fon: +49 2162 / 37 85-0
ea1974@elektroautomatik.de
www.elektroautomatik.de